

PRODUCT USER MANUAL

RM-EGB

COMPACT ELECTRIC FINGER



Please read this MANUAL carefully before using the product.

Product Disclaimer Statement

Dear Customer,

First and foremost, we extend our heartfelt gratitude for choosing products from Foshan Augmented Intelligence Technology Co., Ltd. (hereinafter referred to as "we" or "our company"). This disclaimer aims to clarify the potential risks and responsibilities associated with the use of our products, ensuring that the rights and interests of both parties are effectively protected. Please read the following carefully and thoroughly understand the content.

1. Product Usage Risk Warning

Our products are designed and manufactured in strict accordance with industry standards. Nevertheless, it is inevitable that any product may carry certain risks associated with its use. We strongly advise you to strictly follow operating procedures and safety manuals when using our products to minimize potential risks to the greatest extent. Please note that you should bear the relevant risks associated with the use of our products, including but not limited to product performance, accuracy, and applicability.

2. Disclaimer

We do not assume any liability for any losses or damages caused by the following situations:

- 1) Improper operation, misuse, unauthorized modification, or use beyond the scope of the product.
- 2) The product cannot meet all specific purposes of the user. It is recommended that the user assess whether the product meets their specific needs before use.
- 3) Indirect damages, special damages, incidental damages, or consequential damages caused by product failures, delays, or defects resulting from the use of third-party maintenance services not authorized by our company.
- 4) Any liability arising from the combination of third-party products or services with our products.

3. Copyright and Intellectual Property Statement

All products, services, and trademarks provided by our company are protected by intellectual property laws and other relevant laws and belong to our company. Without our explicit permission, no unit or individual may modify, rent, lease, sell, share, or distribute our products and services in any way.

4. Product Quality Guarantee

Our product quality guarantee is limited to manufacturing defects inherent to the product itself. This guarantee does not apply to products that have been improperly stored, assembled, used, or placed in outdoor or humid environments. It does not cover normal wear and tear, cuts, and scratches, or damages caused by impact or accidents.

5. Applicable Law and Jurisdiction

This disclaimer is governed by and interpreted in accordance with the laws of the People's Republic of China. In the event of any dispute, both parties should first attempt to resolve it through friendly negotiation; if negotiation fails, either party has the right to submit the dispute to the People's Court located where our company is based.

6. Modifications and Updates

We reserve the right to modify, update, upgrade, or discontinue the product at any time. For any modifications to this disclaimer, we will publish updates on our company's website or in the product manual, which will take effect immediately upon publication.

7. Other Terms

This disclaimer does not replace any other contractual relationships between the parties. If there are other contract terms, please comply with them as well.

We look forward to continuing our cooperation with you and are committed to providing you with high-quality products and services.

Preface

Overview

RM-EGB is a compact electric finger with high cost-performance and easy operation. It is equipped with an integrated servo controller for driving and control. It is compact in size, offers a wide range of force output, and has a fast opening and closing speed, exhibiting excellent motion performance. This compact electric finger can easily replace pneumatic grippers of the same specifications and is suitable for the rapid clamping and transportation of various lightweight products and components.

This quick start guide provides comprehensive information on the product, including an overview, installation considerations, instructions, application examples, communication and control methods, software debugging tools, troubleshooting, and maintenance. For first-time use, please be sure to read this manual carefully. If you have any questions or doubts regarding the content of the manual, please feel free to consult RobustMotion for professional guidance.

Applicable Product Models

This Manual applies to all models of RM-EGB (Compact Electric Finger) series.

Features

- Miniature and compact in size, saving space
- Offers a larger range of force output compared to products of the same volume
- Adaptive gripping
- Can grip internally or externally with consistent force output
- 4 preset output force levels, I/O combination trigger without parameter adjustment
- 4 preset stroke levels, I/O combination trigger without parameter adjustment
- Clamp empty and drop detection function
- Can directly replace the pneumatic gripper of same specification

Application

- 3C Electronics Manufacturing
- Automated Production & Assembly
- Battery Manufacturing
- Automation Equipment
- Cosmetics Production
- Other Industries

Precautions

1. This manual serves as a general guide for a series of products. The diagrams provided in the manual are for illustrative purposes only and may differ from the product you have ordered.
2. Our company is committed to the continuous improvement of our products, with ongoing enhancements to product functionality. If you encounter any issues during use, please contact RobustMotion for assistance.

Contents

Product Disclaimer Statement	2
Preface.....	3
1 Product Information	5
1.1 Product Overview	5
1.2 Installation Instructions	6
1.3 Allowable Static Moment Direction of Finger	6
1.4 Clamp's Clamping Point Distance and Tooling Fixture Design Suggestions.....	7
1.5 Function Instructions for Clamping/Outer Support/Drop Detection.....	8
2 Cable Wiring and Use	9
2.1 Wiring Instructions	9
2.2 Insulation Protection of Loose Wire.....	9
2.3 Instructions of Signal Light Indicator	9
2.4 Cable Tying and Securing Protection for Installation	10
2.5 Wiring Sequence Instructions	10
2.6 Circuit Diagram Wiring Illustration.....	11
3 I/O Input and Output Signal Description	13
3.1 Input Signal Description	13
3.2 Output Signal Description.....	13
4 Maintenance.....	14
4.1 First Time Use/ Long Term Non-use.....	14
4.2 Maintenance Frequency	14
4.3 Key Maintenance Areas.....	14
4.3.1 Regular External Cleaning and Lubrication	15
4.3.2 Regular Self-Inspection	16

1 Product Information

1.1 Product Overview

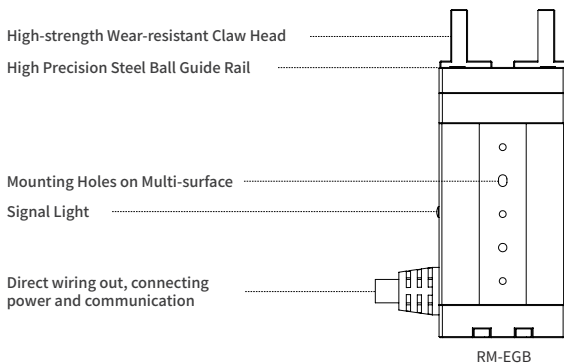

This MANUAL applies to the following product models.

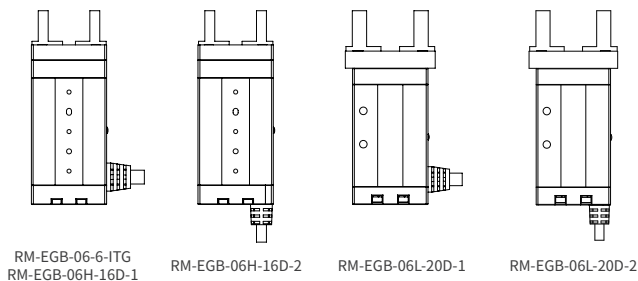

* "1" is the side outlet, "2" is the bottom outlet.

1.2 Installation Instructions

This actuator is equipped with multiple mounting surfaces, allowing users to choose the appropriate mounting surface according to their specific needs and secure it with bolts that match the diameter of the holes. Please follow these guidelines when performing the installation and fixing operation:

- 1) When securing the main body, please use all the threaded holes on the same mounting surface for fixation;
- 2) When tightening the bolts, do not exceed the depth of the threaded holes.

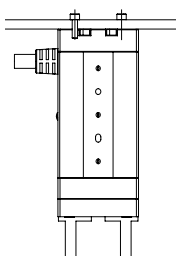

Bottom Mounting Surface

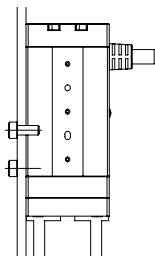

Side Mounting Surface

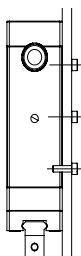

Front Mounting Surface

1.3 Allowable Static Moment Direction of Finger

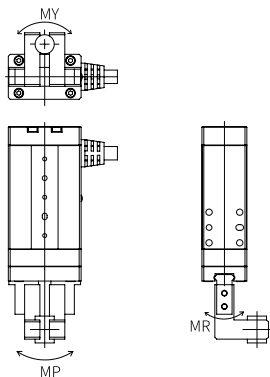

1.4 Clamp's Clamping Point Distance and Tooling Fixture Design Suggestions

Clamp's clamping point distance:

Please use the distance (L, H) from the mounting surface to the clamping point within the following range. Exceeding the limit range may cause excessive load torque being applied to the slider and internal mechanism of the gripper, potentially reducing its service life.

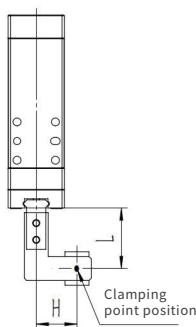
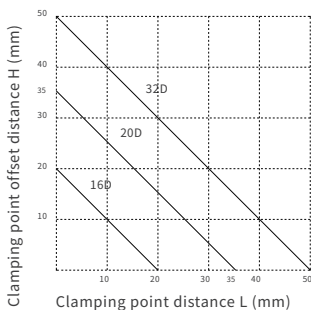

- Even if the gripping point is within the restricted range, choosing smaller and lighter fixtures is advisable whenever possible.
- When the clamp is too long, too large, or has excessive mass, the inertial force and bending load torque generated during the opening and closing operations can impact the mechanical body, potentially leading to a decrease in performance or adverse effects on the guide rail section.

1.5 Function Instructions for Clamping/Outer Support/Drop Detection

* Requirements for use of outer support/drop detection

$$S1 + 0.5\text{mm} < S2$$

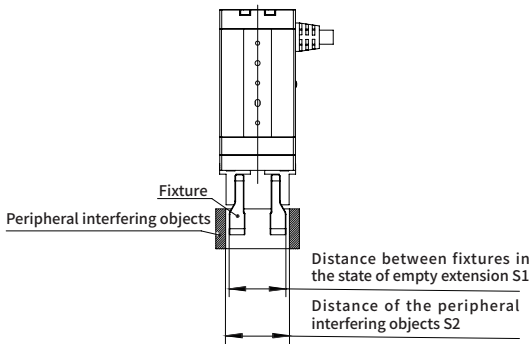

* Clamp/drop detection function requires

$$S3 > 0.5\text{mm}$$

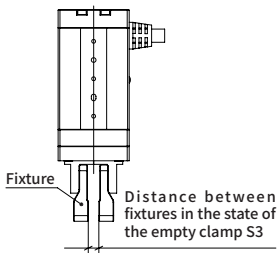

* Clamp/drop detection function requires

$$16D: S5 - S4 < 6\text{mm}$$

$$20D: S5 - S4 < 10\text{mm}$$

$$32D: S5 - S4 < 22\text{mm}$$

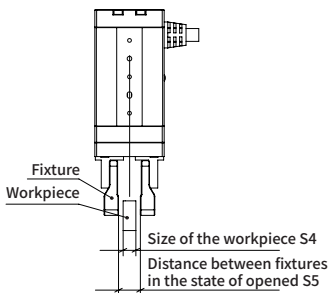

2 Cable Wiring and Use

2.1 Wiring Instructions

1. When using, there is no need to adapt the female connector to the plug, you can cut off the plug end yourself.
2. Just follow the wire markings on the cables or the following wire sequence instructions to wire the cables accordingly.

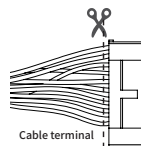

2.2 Insulation Protection of Loose Wire

Loose wires that are not in use must be insulated to prevent short circuits caused by accidental contact of the wires.

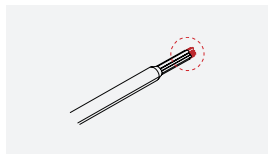
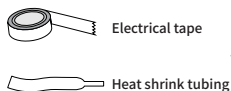

2.3 Instructions of Signal Light Indicator

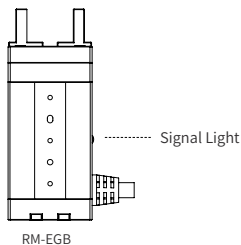

I/O type is NPN	I/O type is PNP
<ul style="list-style-type: none"> • Green: Initializing upon power-on • Blue: Indicates the EGB is in operable state • Purple: Workpiece clamped (internally / externally) by IO 	<ul style="list-style-type: none"> • Blue: Initializing upon power-on • Green: Indicates the EGB is in operable state • Yellow: Workpiece clamped (internally / externally) by IO

2.4 Cable Tying and Securing Protection for Installation

1. Recommendations for tying cable on device modules

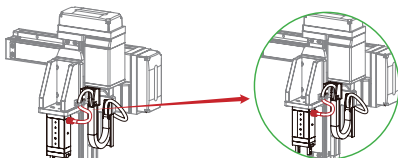

Tank chain (protect cable)

2. Recommendations for tying cable when used on robotic arms

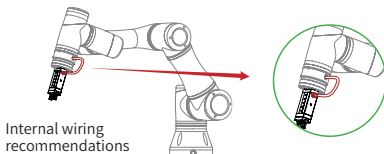

Internal wiring recommendations

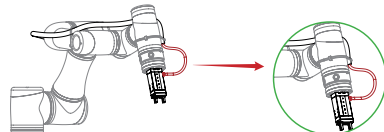

External wiring recommendations

Corrugated tube (protect cable)



The 20cm long part of the cable outlet from the gripper (the part shown in red) must be as static as possible with the gripper body to ensure effective fixation and prevent cable damage caused by bending/twisting below the minimum bending radius (56mm).

2.5 Wiring Sequence Instructions

		Group	Color	Definition	Description
A2008H-12	PIN1	I/O output	Red	OUT0	NPN output 0
	PIN2		Orange	OUT1	NPN output 1
	PIN3		Black	OUT2	NPN output 2
	PIN4	I/O input	Purple	IN0	NPN input 0
	PIN5		Grey	IN1	NPN input 1
	PIN6		White	IN2	NPN input 2
	PIN7	Main power supply	Brown	24V	Actuator power supply 24V
	PIN8		Blue	0V	Actuator power supply 0V
	PIN9	485	Yellow	DSW +	485 +
	PIN10		Green	DSW -	485 -

Note: Different batches of cables may cause slight differences in the color of the wire core. Please refer to the actual color of the cable for details.

2.6 Circuit Diagram Wiring Illustration

1. When both the PLC and RM-EGB feature NPN I/O types, the wiring method is as follows:

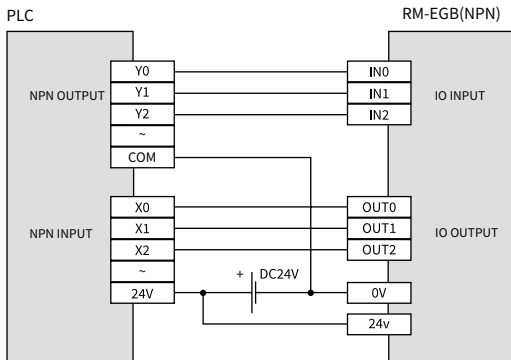

2. When both the PLC and RM-EGB feature PNP I/O types, the wiring method is as follows:

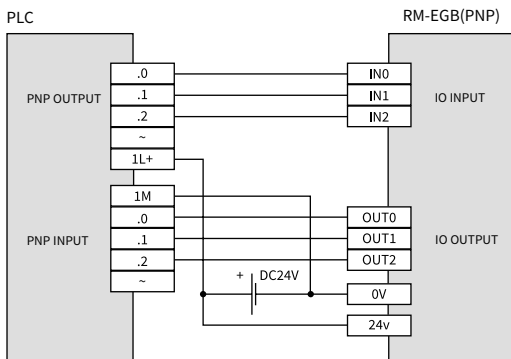

CABLE WIRING AND USE

3. When the PLC I/O type is PNP, while the RM-EGB I/O type is NPN, indirect control can be achieved by using a relay wiring method, as follows:

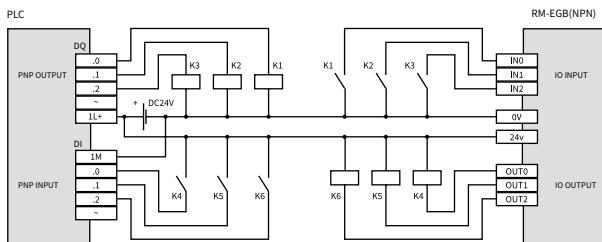

It is also possible to use a PNP to NPN converter or an NPN to PNP converter (as shown in the following figure) to achieve a high-to-low or low-to-high level conversion.

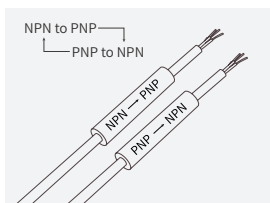

Note: The PNP to NPN converter, or NPN to PNP converter, should be wired strictly following the wiring method provided by the cable manufacturer.

3 I/O Input and Output Signal Description

The RM-EGB supports I/O control with 3 inputs and 3 outputs. The product has preset multiple output levels and stroke, which can be achieved through the combination of I/O triggers, eliminating the need to connect external devices for parameter adjustment.

3.1 Input Signal Description

No.	IN0	IN1	IN2	16D	20D	32D
1				Open to limit, strength 100%	Open to limit, strength 100%	Open to limit, strength 100%
2		■		Position to 2mm, strength 100%	Position to 4mm, strength 100%	Position to 6mm, strength 100%
3			■	Position to 4mm, strength 100%	Position to 8mm, strength 100%	Position to 15mm, strength 100%
4		■	■	Open to limit, strength 50%	Open to limit, strength 50%	Open to limit, strength 50%
5	■			Clamp to limit, strength 100%	Clamp to limit, strength 100%	Clamp to limit, strength 100%
6	■	■		Clamp to limit, strength 75%	Clamp to limit, strength 75%	Clamp to limit, strength 75%
7	■		■	Clamp to limit, strength 50%	Clamp to limit, strength 50%	Clamp to limit, strength 50%
8	■	■	■	Clamp to limit, strength 25%	Clamp to limit, strength 25%	Clamp to limit, strength 25%

■: Indicates that the signal is in an ON state. If it is blank, it indicates an OFF state.

3.2 Output Signal Description

No.	OUT0	OUT1	OUT2	Description
1				In motion
2		●		Open in place (detection of workpiece without external support or workpiece with external support falling)/positioning movement in place
3		●	●	Opened in place and the outer support detects the workpiece
4	●			Clamp in place, detect no clamped workpiece/fall of clamped workpiece
5	●	●		The clamp is in place and the clamp detects the workpiece
6			●	The positioning movement is not in place and the strength reaches 100%
7	●	●	●	Equipment abnormality

●: Indicates that the signal is in an ON state. If it is blank, it indicates an OFF state.

4 Maintenance

4.1 First Time Use/ Long Term Non-use

1. Before the initial use, please confirm whether the interval from the date of receipt to the first use exceeds half a month (reduce appropriately in winter). If it does, it is recommended to apply a small amount of WD-40 rust-preventing lubricant to the actuator's screw rod, guide rail, and other transmission components before use, and move back and forth 3-5 times to allow the lubricant to fully contact the transmission components, ensuring the actuator is in optimal condition.
2. If the actuator has not been used for more than half a month / has been left unused for an extended period: It is necessary to first apply a small amount of WD-40 rust-preventing lubricant before use, especially when accessing travel ranges that have not been utilized for a long time.



- WD-40 rust-preventing lubricant should only be used in the aforementioned situations.
- For regular daily maintenance, please use NSL grease.
- Please use lubricants that are compatible with the specified grease to avoid abnormal chemical reactions that could cause mechanical damage.

4.2 Maintenance Frequency

	Check transmission parts regularly	Regularly check the tightness of connecting screws	Regular grease replenishment
Put into service	○		
Run for 1 month	○	○	
Run for 6 month	○	○	○
Run for 1 Year	○	○	○
Later every half year	○	○	○

Note: the above is based on operation on 5 working days a week (8 hours/day).

If the actuator needs to run day and night or be used frequently, and/or the use environment is relatively harsh (such as high dust, high temperature, etc.), please shorten the inspection period relatively.

4.3 Key Maintenance Areas

	Grease replenishment cycle	Grease supply part
RM-EGB series of electric fingers	200W times per opening and closing or half a year	Guide

4.3.1 Regular External Cleaning and Lubrication

The guiding components such as the guide fingers in this type of product are typically exposed to the air, and during the regular maintenance cycle, these parts may accumulate dust or other dark-colored impurities. To maintain the performance of the product and extend its service life, it is recommended to regularly clean and lubricate the product itself as well as its surrounding environment. When severe dirt is present on the product's surface or after a certain period of use, the following steps should be taken for cleaning, and the specific cleaning frequency should be determined based on the specific working environment.

① Cleaning

First, spray WD-40 rust-preventing lubricant into the corners of the ball slot, then let it sit for about 10 minutes, as shown in Figure 1.

Next, use a specialized brush or rag to wipe away the main dust and impurities, as depicted in Figure 2.

Finally, manually open and close the fingers back and forth to clean the guide rail multiple times, as illustrated in Figure 3.

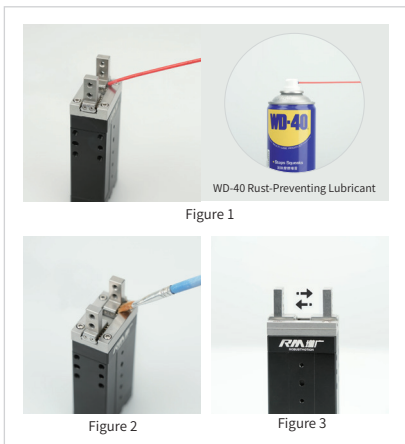

② Replace the Grease

After the previous step, the old lubricant should have been mostly cleaned off. Next, move the fingers to their maximum travel and use a specialized fine brush to apply NSL grease, filling all the narrow gaps of the balls with grease, as shown in Figure 4.



③ Remove Excess Grease

After applying the grease, the product will generally be in the condition shown in Figure 5;

To maintain the overall aesthetic of the equipment, it is recommended to wipe off the excess grease with a clean cloth;



Figure 5

④ Anti-Rust Treatment for Guide Fingers

The anti-rust capability of guide fingers is related to the presence of an oil film on their surface. Therefore, when wiping off the excess lubricating grease, you can wipe the entire surface once to ensure that a layer of oil film adheres to the surface, as shown in Figure 6.



Figure 6

4.3.2 Regular Self-Inspection

- It is recommended to manually open and close the fingers for a complete stroke 3 to 5 times each time before powering on or changing the usage stroke. This practice helps to keep the clamps in optimal condition and prevents abnormal movement or alarms due to increased resistance introduced by the slider.
- If any of the aforementioned abnormalities are detected during the self-check process, please follow the cleaning and maintenance procedures outlined in [4.3.1: Regular external cleaning and lubrication]

USAGE GUIDE AND SERVICE SUPPORT



en.rmaxis.com/download

Scan the QR code for instant access to the Product User Manual and RMS Debugging Software.

Before use, please read the user manual carefully and properly install, debug, and use the product.



No Hot Plugging



Select the Correct Power Supply



Please Ensure Proper Wire Bundling Protection

Thank you for choosing RobustMotion!

Tel.: 0086-0757-22205682

E-mail: Overseas@rmaxis.com

ADD: 1st Floor, No. 20, Shunxiang Road, XinjiaoCommunity, Daliang Street, Shunde District, Foshan City, Guangdong Province, China

Declaration: Users must thoroughly assess whether the product meets their specific requirements before use. During operation, all procedures and safety guidelines must be strictly followed.

RobustMotion assumes no liability for any direct or indirect losses resulting from improper operation, misuse, unauthorized modification, or use beyond the product's specified scope. All associated risks and consequences shall be borne solely by the user.



Find more at en.rmaxis.com