

Stroke	20	40
L1	108	128
L2	90	110
L3	63	73
L4	0~22	0~42

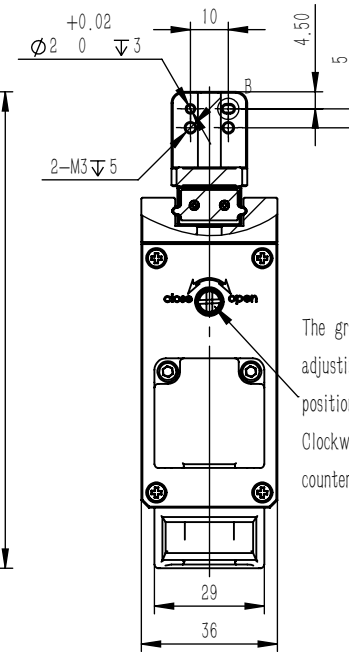

The gripper can be controlled by adjusting this one-piece screw position when powered down. Clockwise direction is open and counterclockwise is close.

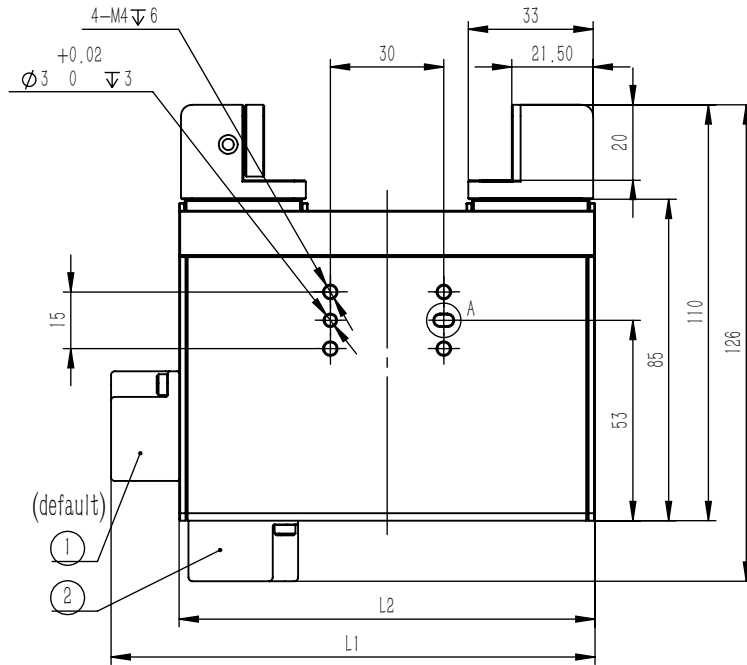
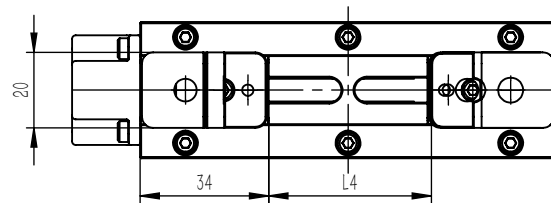

Note:

1. Stroke 40 Gripper can select any of the output cable positions (① or ②);
2. Stroke 20 Gripper only have one output cable positions (①);
3. When fixing the main body, please make use of all the screw holes on same mounting surface;
4. Don't exceed the depth of the threaded hole when tightening the bolt.