

Unit: mm

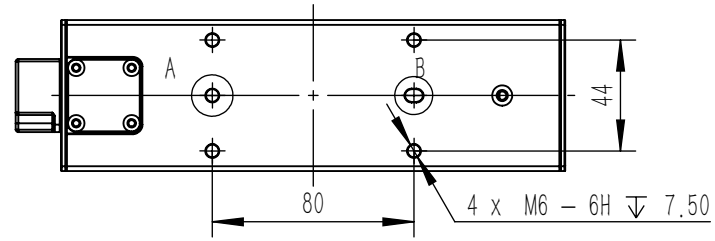

Stroke	80	120
L1	200	240
L2	218	258
L3	16~96	16~136

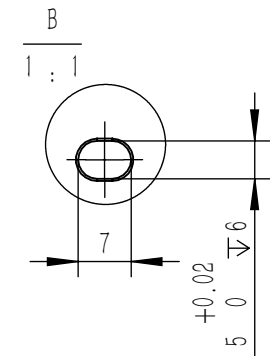
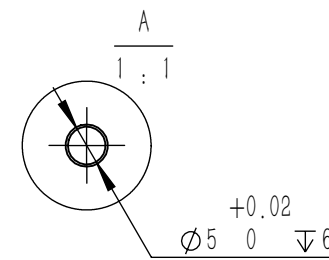
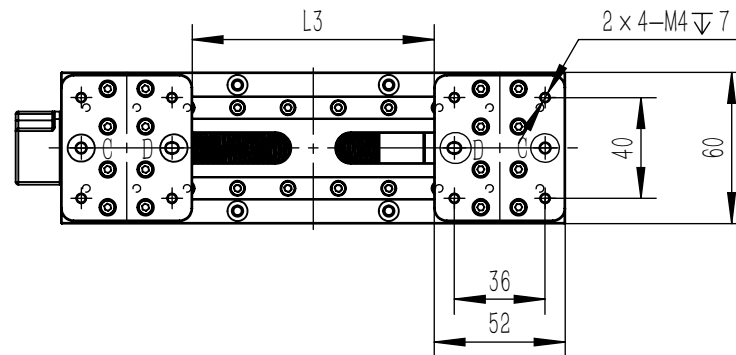
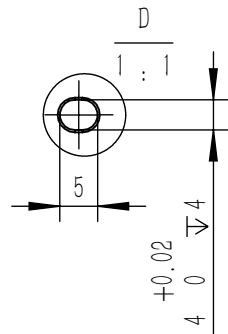
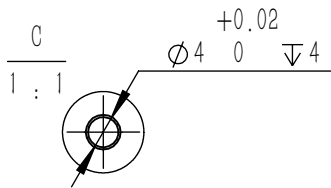
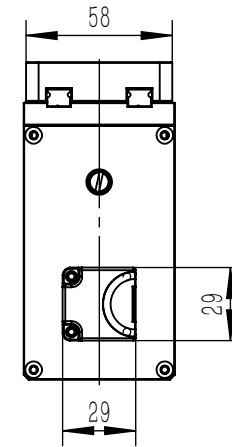
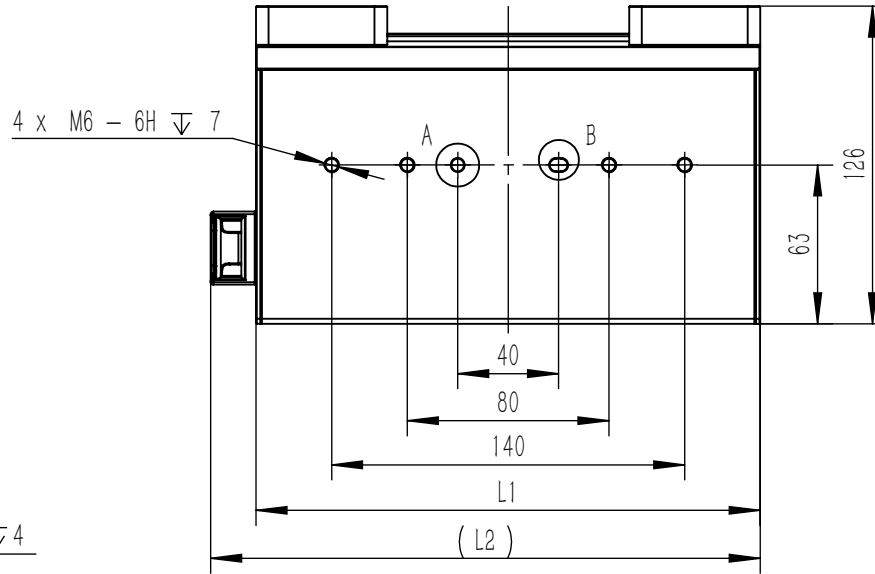
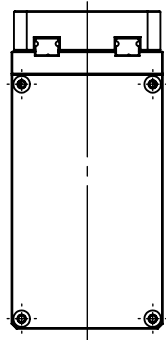

Note:

1. When fixing the main body, please make use of all the screw holes on same mounting surface,
2. Don't exceed the depth of the threaded hole when tightening the bolt.